

# TO-252 Plastic-Encapsulate MOSFETS

## LJ630N

### Description

The LJ630N uses advanced trench technology and design to provide excellent  $R_{DS(ON)}$  with low gate charge. It can be used in a wide variety of applications.

### General Features

- $V_{DS} = 200V, I_D = 8A$   
 $R_{DS(ON)} < 300m\Omega @ V_{GS} = 10V$  (Typ: 260m $\Omega$ )
- High density cell design for ultra low  $R_{dson}$
- Fully characterized avalanche voltage and current
- Low gate to drain charge to reduce switching losses

### Application

- Power switching application
- Hard switched and high frequency circuits
- Uninterruptible power supply

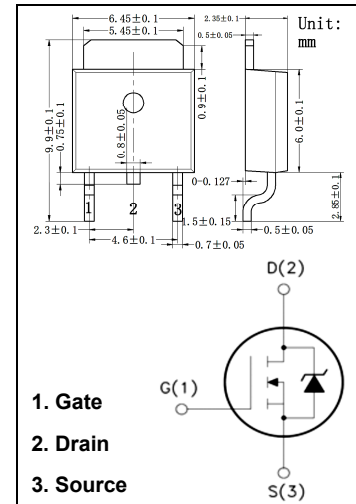

### Absolute Maximum Ratings ( $T_C = 25^\circ C$ unless otherwise noted)

Parameter	Symbol	Limit	Unit
Drain-Source Voltage	$V_{DS}$	200	V
Gate-Source Voltage	$V_{GS}$	$\pm 20$	V
Drain Current-Continuous	$I_D$	8	A
Drain Current-Continuous( $T_C = 100^\circ C$ )	$I_D(100^\circ C)$	5.6	A
Pulsed Drain Current	$I_{DM}$	20	A
Maximum Power Dissipation	$P_D$	55	W
Operating Junction and Storage Temperature Range	$T_J, T_{STG}$	-55 To 150	$^\circ C$

### Thermal Characteristic

Thermal Resistance, Junction-to-Case <sup>(Note 2)</sup>	$R_{\theta JC}$	2.3	$^\circ C/W$
--	-----------------	-----	--------------

## Electrical Characteristics ( $T_C=25^{\circ}\text{C}$ unless otherwise noted)

Parameter	Symbol	Condition	Min	Typ	Max	Unit
<b>Off Characteristics</b>						
Drain-Source Breakdown Voltage	$BV_{DSS}$	$V_{GS}=0V, I_D=250\mu A$	200	215	-	V
Zero Gate Voltage Drain Current	$I_{DSS}$	$V_{DS}=200V, V_{GS}=0V$	-	-	1	$\mu A$
Gate-Body Leakage Current	$I_{GSS}$	$V_{GS}=\pm 20V, V_{DS}=0V$	-	-	$\pm 100$	nA
<b>On Characteristics</b> (Note 3)						
Gate Threshold Voltage	$V_{GS(th)}$	$V_{DS}=V_{GS}, I_D=250\mu A$	1	1.7	2.5	V
Drain-Source On-State Resistance	$R_{DS(on)}$	$V_{GS}=10V, I_D=4.5A$	-	260	300	m $\Omega$
Forward Transconductance	$g_{FS}$	$V_{DS}=25V, I_D=4.5A$	3	-	-	S
<b>Dynamic Characteristics</b> (Note 4)						
Input Capacitance	$C_{iss}$	$V_{DS}=25V, V_{GS}=0V,$ $F=1.0\text{MHz}$		540		PF
Output Capacitance	$C_{oss}$			90		PF
Reverse Transfer Capacitance	$C_{rss}$			35		PF
<b>Switching Characteristics</b> (Note 4)						
Turn-on Delay Time	$t_{d(on)}$	$V_{DD}=100V, I_D=4.5A$ $V_{GS}=10V, R_{GEN}=5\Omega$	-	6.4	-	nS
Turn-on Rise Time	$t_r$		-	11	-	nS
Turn-Off Delay Time	$t_{d(off)}$		-	20	-	nS
Turn-Off Fall Time	$t_f$		-	12	-	nS
Total Gate Charge	$Q_g$	$V_{DS}=160V, I_D=4.5A,$ $V_{GS}=10V$	-	16	-	nC
Gate-Source Charge	$Q_{gs}$		-	3.4	-	nC
Gate-Drain Charge	$Q_{gd}$		-	5.1	-	nC
<b>Drain-Source Diode Characteristics</b>						
Diode Forward Voltage (Note 3)	$V_{SD}$	$V_{GS}=0V, I_S=8A$	-	-	1.2	V
Diode Forward Current (Note 2)	$I_S$		-	-	8	A

### Notes:

1. Repetitive Rating: Pulse width limited by maximum junction temperature.
2. Surface Mounted on FR4 Board,  $t \leq 10$  sec.
3. Pulse Test: Pulse Width  $\leq 300\mu s$ , Duty Cycle  $\leq 2\%$ .
4. Guaranteed by design, not subject to production

Test Circuit

1)  $E_{AS}$  test Circuit

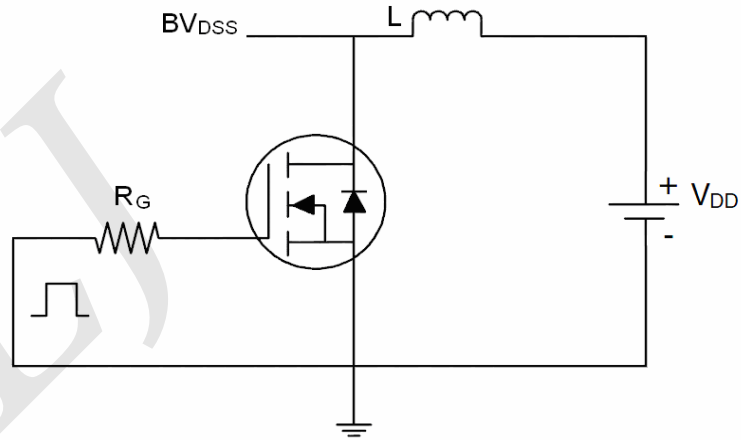

2) Gate charge test Circuit

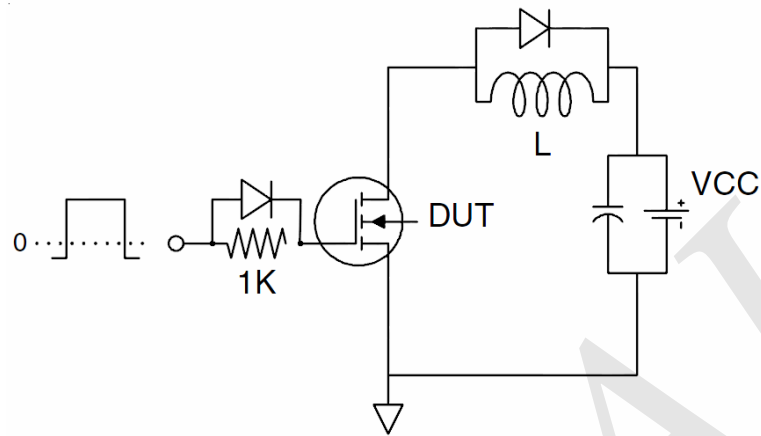

3) Switch Time Test Circuit

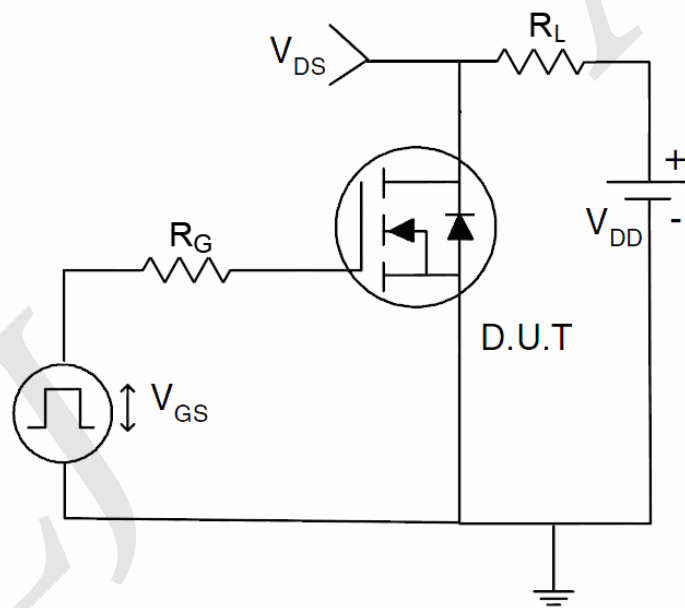

# Typical Characteristics

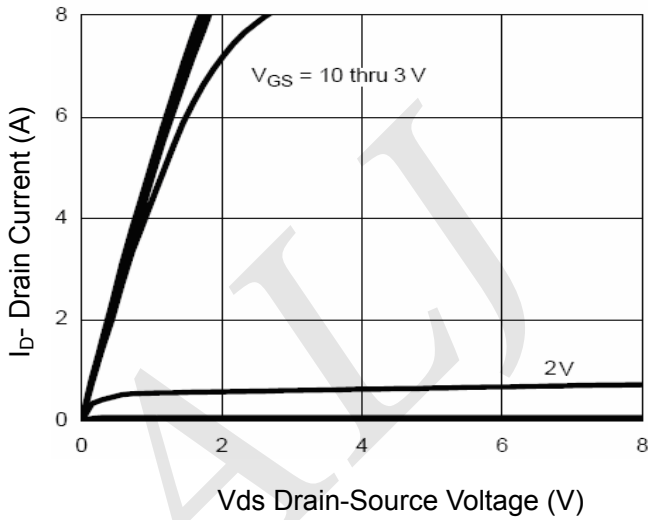

**Figure 1 Output Characteristics**

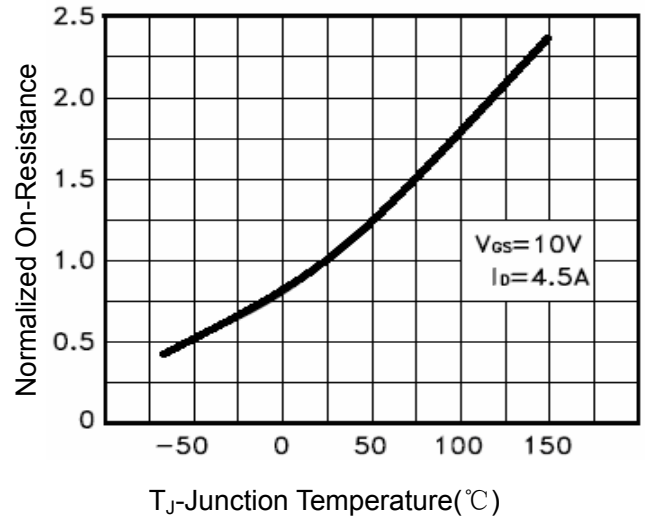

**Figure 4 Rdson-Junction Temperature**

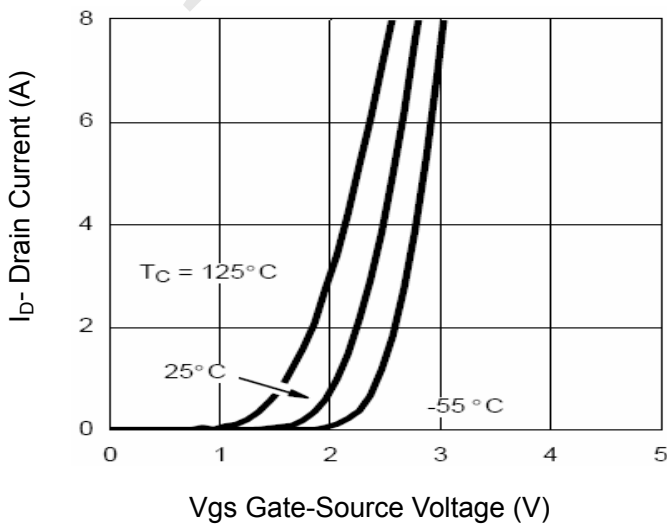

**Figure 2 Transfer Characteristics**

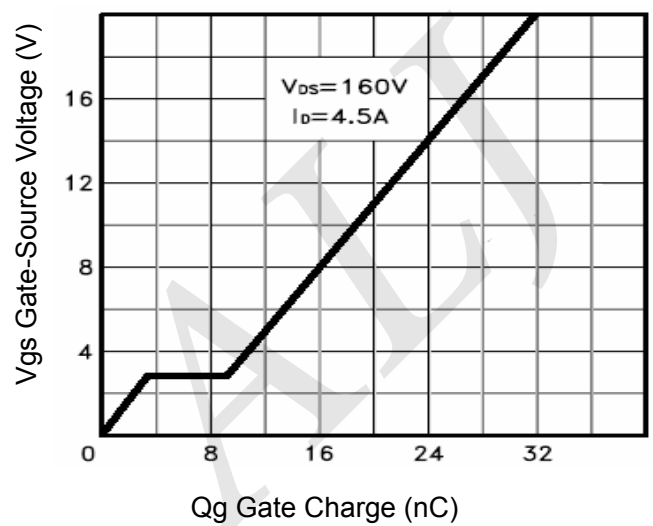

**Figure 5 Gate Charge**

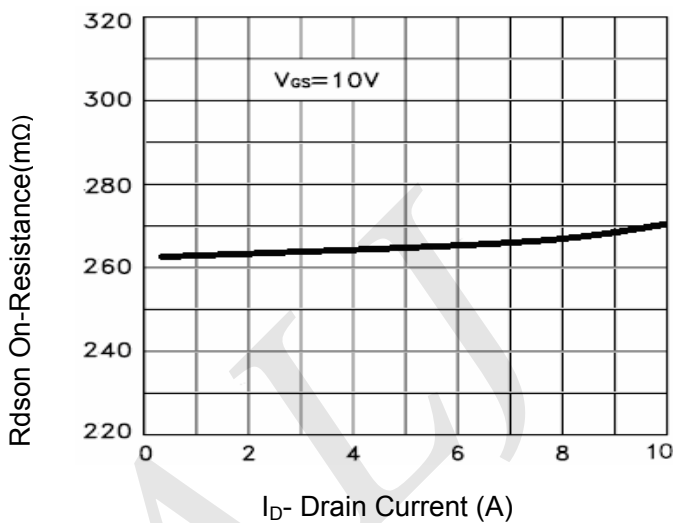

**Figure 3 Rdson- Drain Current**

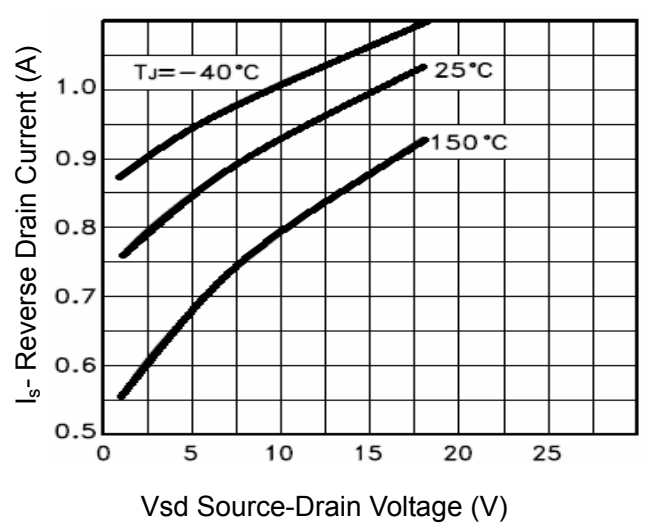

**Figure 6 Source- Drain Diode Forward**

# Typical Characteristics

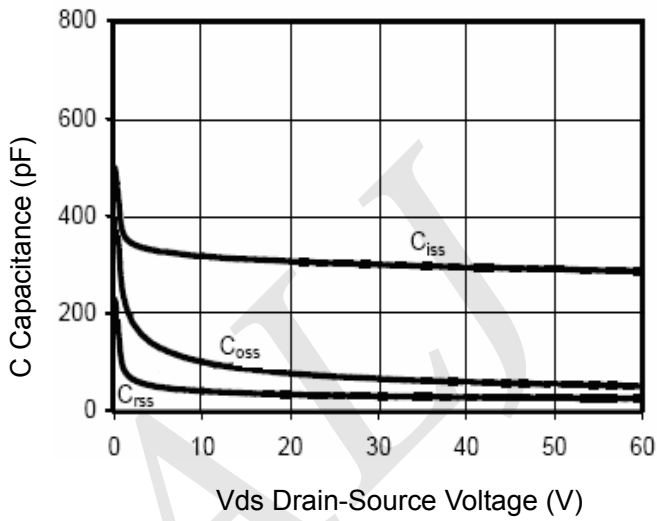

Figure 7 Capacitance vs Vds

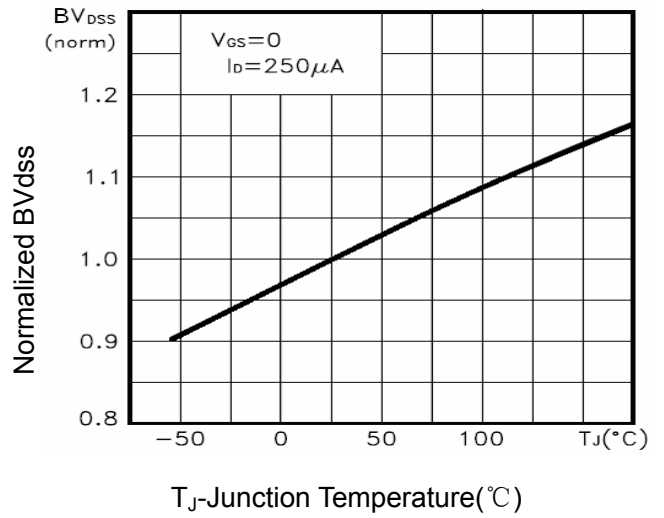

Figure 9  $BV_{DSS}$  vs Junction Temperature

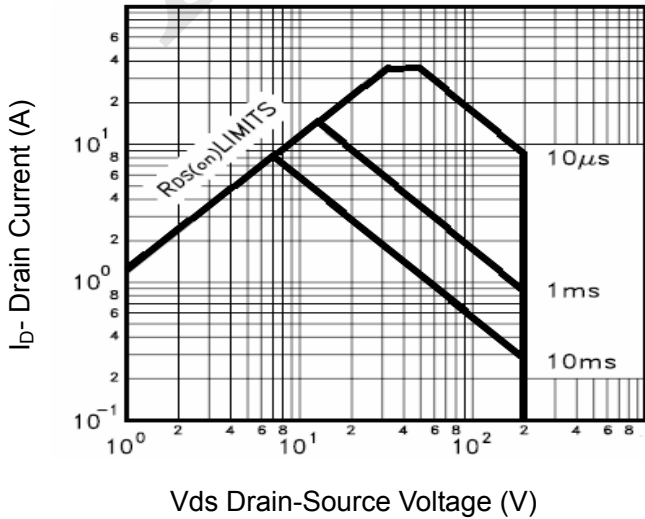

Figure 8 Safe Operation Area

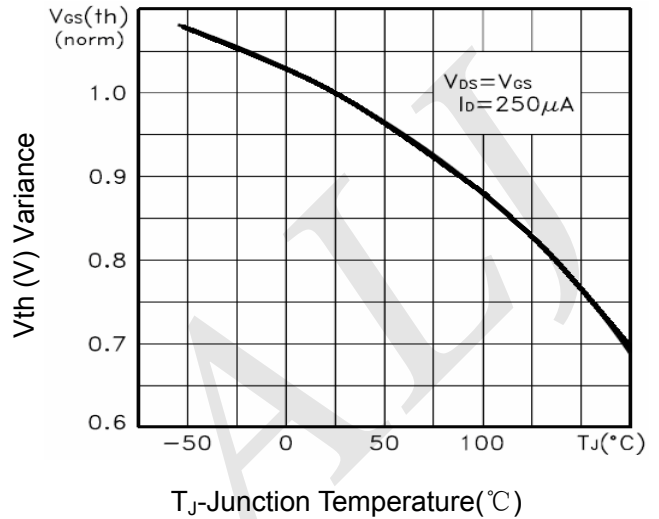

Figure 10  $V_{GS(th)}$  vs Junction Temperature

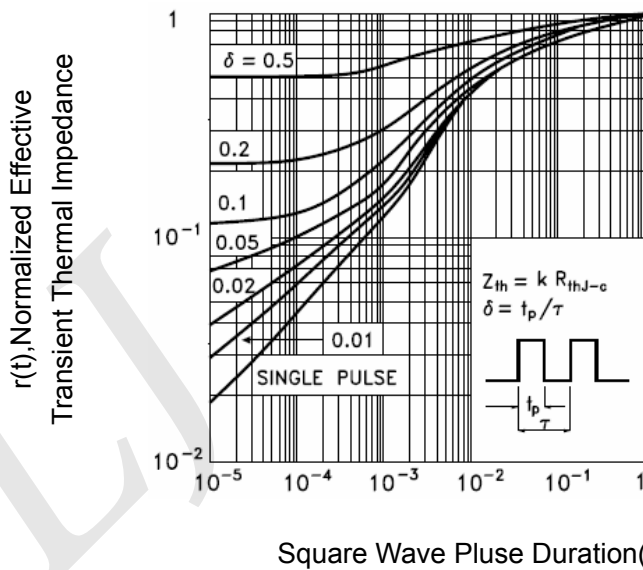

Figure 11 Normalized Maximum Transient Thermal Impedance